

LIMITADORES

FLEXIBLE PARCIAL

PARTIALLY FLEXIBLE / PARTIELLEMENT FLEXIBLE

POLIETILENO

Mod. C-430



Mod. C-430 (para chumbar)

Absorve impactos de veículos e recupera a verticalidade a 100%

Flexível até 20º sem danificar, recuperando a posição completamente

Flexão até cargas de 150 kg

ALG - Tratamento de Águas, Lda.

rua: Dr. Francisco Sá Carneiro, 25 A • 4780-448 Santo Tirso • nif: 502 951 729 • tel.: +351 252 861 305 • tlm.: +351 932 398 469

skype: azevedo-alg • e-mail 1: geral@alg.pt • e-mail 2: geral.alg@gmail.com • web: www.alg.pt



▲
Mod. C-430-TPU

Combinação plástica com base de poliuretano
Absorve impactos de veículos e recupera a verticalidade a 100%
Sem manutenção, oxidação e resistente aos UV

▲
Mod. C-440

C-430-PTU
Com opção extraível

ALG - Tratamento de Águas, Lda.

rua: Dr. Francisco Sá Carneiro, 25 A • 4780-448 Santo Tirso • nif: 502 951 729 • tel.: +351 252 861 305 • tlm.: +351 932 398 469

skype: azevedo-alg • e-mail 1: geral@alg.pt • e-mail 2: geral.alg@gmail.com • web: www.alg.pt



▲ **ONA**
Mod. C-516



▲ **SALT**
Mod. C-507
Mod. C-507G

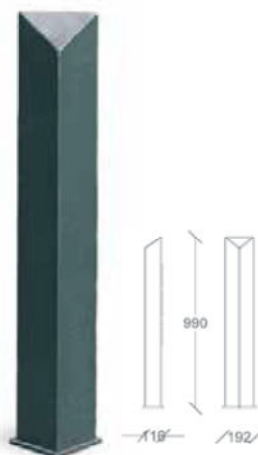

▲ **AQUALATA**
Mod. C-508



▲ **TRANG**
Mod. C-505

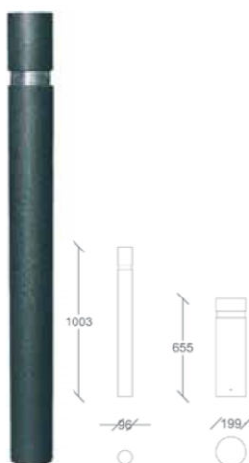

▲ **BARCELONA 2**
Mod. C-43
Mod. C-43G

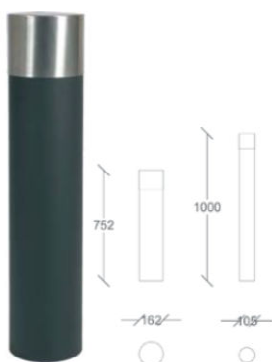

▲ **SANT CUGAT**
Mod. C-522
Mod. C-522G



▲ **MONTREAL**
Mod. C-500
Mod. C-500-CH

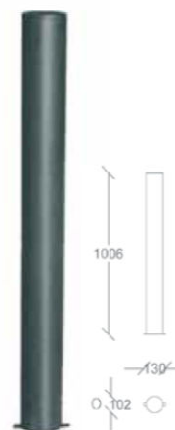

▲ **TUBO**
Mod. C-502

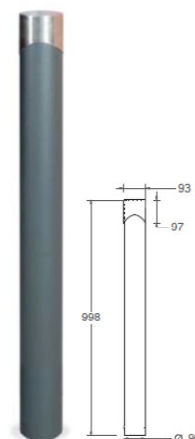

▲ **DUNA**
Mod. C-525





▲ **PILONA GREY**
Mod. C-517



▲ **PARKING ABATIBLE**
Mod. P-A

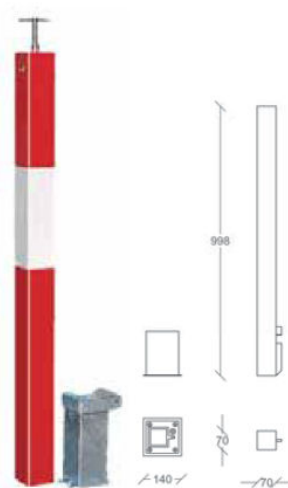

▲ **PARKING EXTRAIBLE**
Mod. P-E

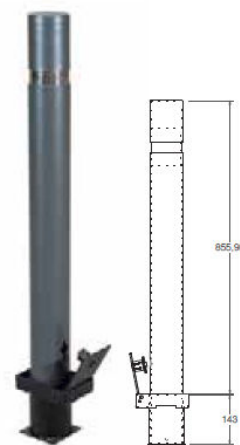

▲ **ECO**
Mod. C-43D-ECO

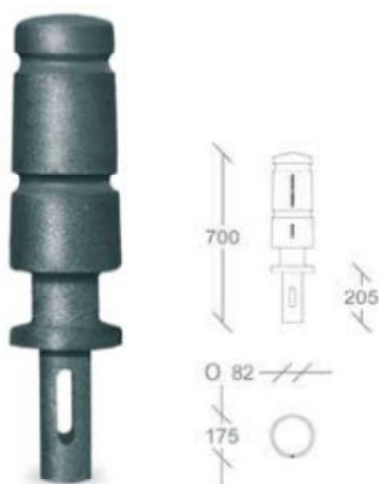

▲ **CIBELES**
Mod. C-602



▲ **ESFERA**
Mod. C-44
Mod. C-44A

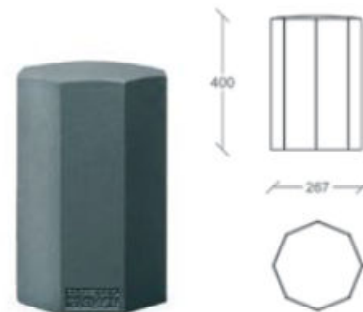

▲ **CALIVIÀ**
Mod. C-515



▲ **MARSELLA**
Mod. C-45M



▲ **GIRONA**
Mod. C-45C



▲ **VALENCIA NOVA**
Mod. C-46

BASES



◀ **BASE VARIO-500**

Base desmontable sin tapa / Removable base uncovered / Base amovible découvert
PILONAS COMPATIBLES / COMPATIBLE BOLLARDS / POTELETS COMPATIBLES:



C-430 C-516 C-43G C-502 C-500 C-40 C-45A C-45N C-45E C-601
C-45AP



◀ **BASE VARIO-501**

Base desmontable con tapa / Removable base with cover / Base amovible avec couvert
PILONAS COMPATIBLES / COMPATIBLE BOLLARDS / POTELETS COMPATIBLES:



C-43 ECO C-40P C-45P C-45M C-45C C-517

APARCAMENTO DE BICICLETAS



CINZEIROS

Adaptáveis a papeleiras



▲
Mod. CE-2

▲
Mod. CE-4

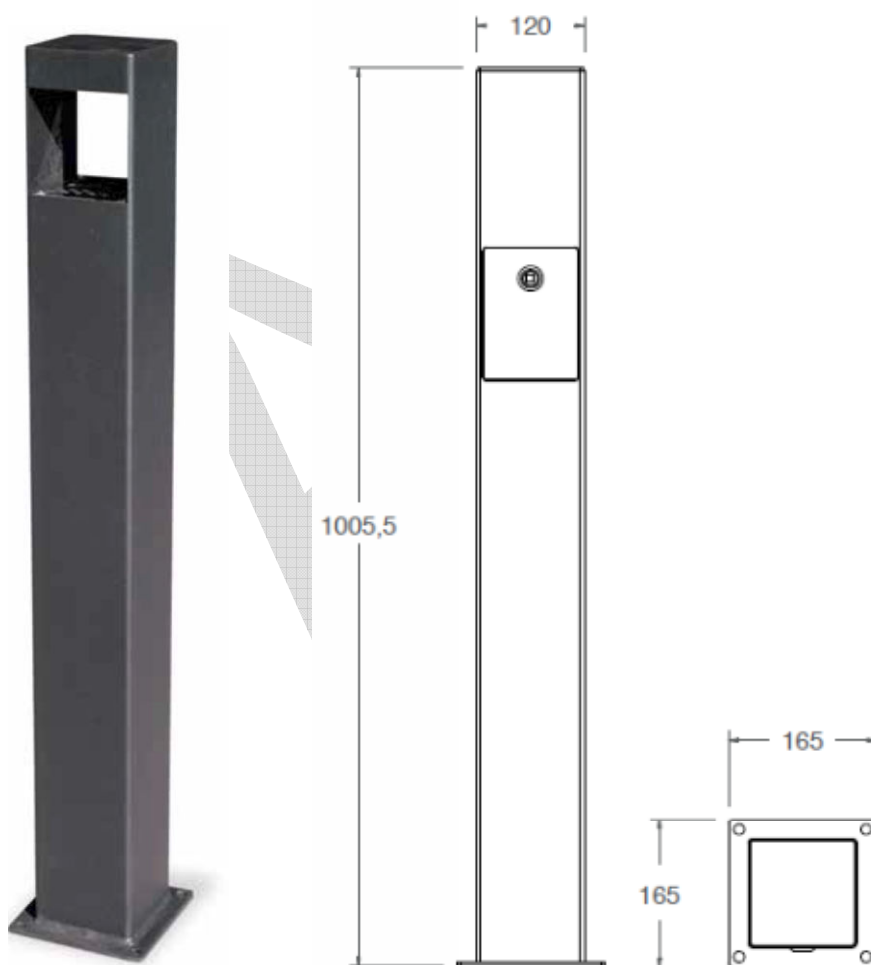

Mod. CE-3
Cinzeiro de aço pintado em oxirón negro

LIMITADORES DE VELOCIDADE

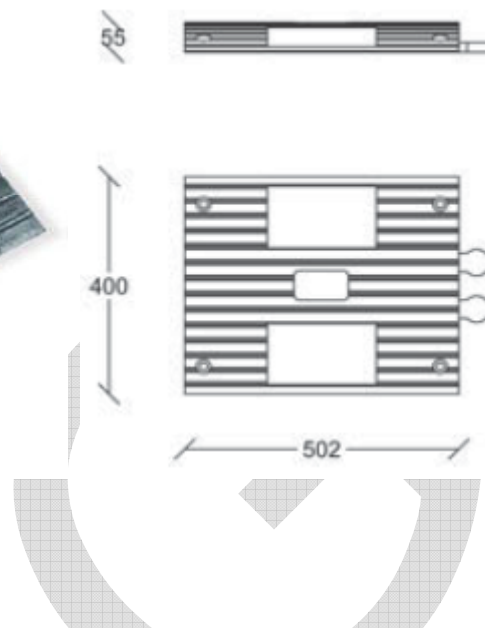
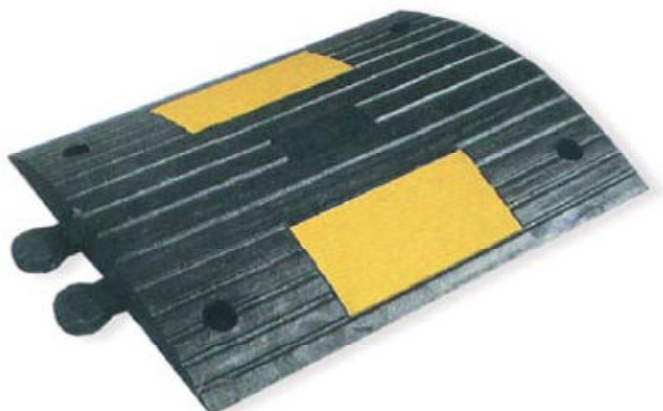

Em borracha reciclada com bandas reflectoras.

- Mod. RE-1 50x40x5 cm
- Mod. RE-1-FM 25x40x5 cm
- Mod. RE-1-FH 25x40x5 cm

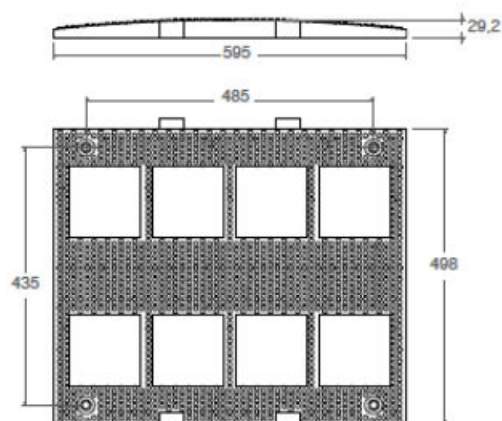
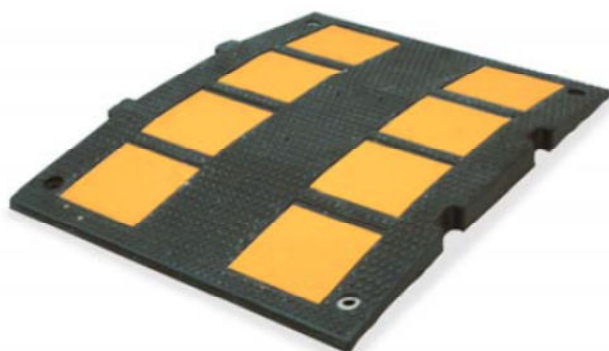

Em borracha reciclada com bandas reflectoras.

- Mod. RE-2 47x60x3 cm
- Mod. RE-2-FM 23x60x3 cm
- Mod. RE-2-FH 23x60x3 cm

SEPARADORES



Em polietileno 100%

TAMPAS

Fundição e compósito



R-1C

Tapa abatible y articulada con cierre antirrobo.
Extraíble a 90°. Bloqueo de seguridad.
Junta de insonorización en polietileno.

Hinged and articulated cover with anti-theft lock.
Removable to 90°. Security lock.
Soundproofing polyethylene joint.

Couvercle abattant et articulé avec serrure anti-vol.
Amovible à 90°. Serrure de sécurité.
Avec joint polyéthylène.

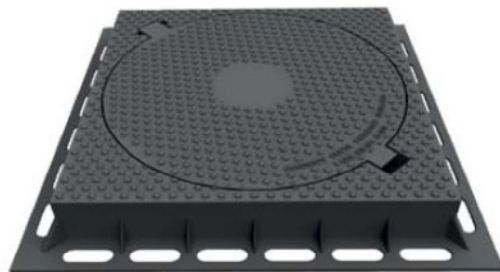

R-3

Marco cuadrado. Tapa abatible y articulada.
Cierre elástico "click".
Extraíble a 90°. Bloqueo de seguridad.
Junta de insonorización en polietileno.

Square frame. Hinged and articulated cover.
Elastic "click" locking.
Removable to 90°. Security lock.
Soundproofing polyethylene joint.

Cadre carré. Couvercle abattant et articulé.
Fermeture arbalète fléchissant avec un "clic".
Amovible à 90°. Serrure de sécurité.
Avec joint polyéthylène.

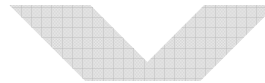
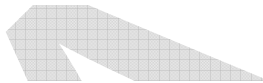
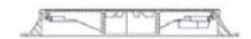
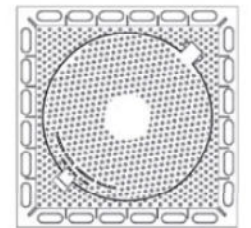

KP-R-1

Tapa y aro redondo para pozo de registro.

Round manhole covers.

Regard de Chaussée ronde.



GRELHAS E CANAIS

Fundição e compósito

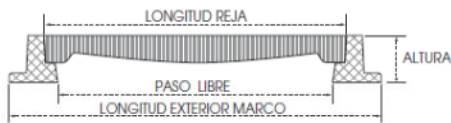

BARCELONA

Abatible.
Reversible al sentido del agua.
Antirrobo.
Para rigola de 30 mm.

Hinged.
Reversible to the direction of water.
Anti-theft device.
For concrete gutters of 30 mm.

Rabattable.
Réversible à la direction de l'eau.
Système antivol.
Pour fossé en béton de 30 mm.



TEIDE

Abatible antirrobo.
Los barrotes facilitan la absorción de agua e impiden el atasco de hojas y restos.

Hinged and anti-theft.
Bars facilitate the absorption of water et and they prevent clogging of leaves and debris.

Rabattable antivol.
Des barres facilitent l'absorption de l'eau et préviennent l'obstruction des feuilles et des débris.

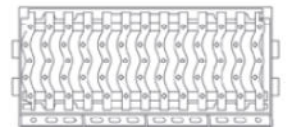

CÓNCAVA

Abatible antirrobo.

Hinged and anti-theft.

Rabattable antivol.



NOVEDAD

KPF-U

Conjunto canal y reja.

Channel and grate.

Caniveaux et grille.

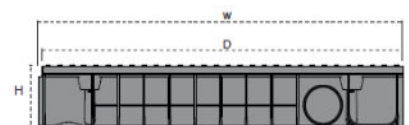
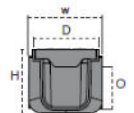

Portugal-Santo Tirso, 2017

ALG - Tratamento de Águas, Lda.

rua: Dr. Francisco Sá Carneiro, 25 A • 4780-448 Santo Tirso • nif: 502 951 729 • tel.: +351 252 861 305 • tlm.: +351 932 398 469

skype: azevedo-alg • e-mail 1: geral@alg.pt • e-mail 2: geral.alg@gmail.com • web: www.alg.pt